

L046-35-M12

Description

35mm M12 low distortion lens



Specifications

Focal Length	35mm
Aperture	f/2.5
Image Size	1/2"
Angle of View	H: 11.0°
Mount Type	M12 x 0.5-6g
Minimum Object Distance	0.3m
Back focal length	14.25mm
External Dimensions	<ul style="list-style-type: none">• D=20mm• L=33.4mm
Net Weight	37g

Dimensions

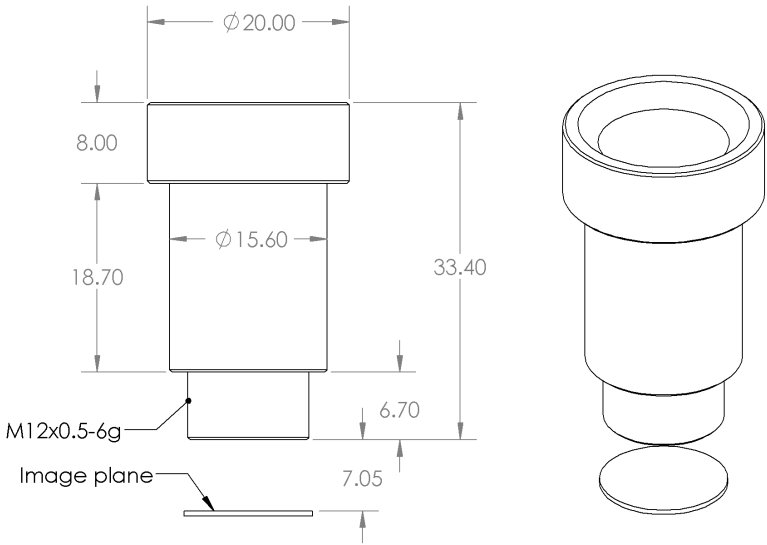

Revision #1
Created 5 January 2023 09:59:26 by Saulius
Updated 28 August 2025 18:01:02 by Saulius